

Instruction Manual
Model: iFighter-5000/7500
PowerBank

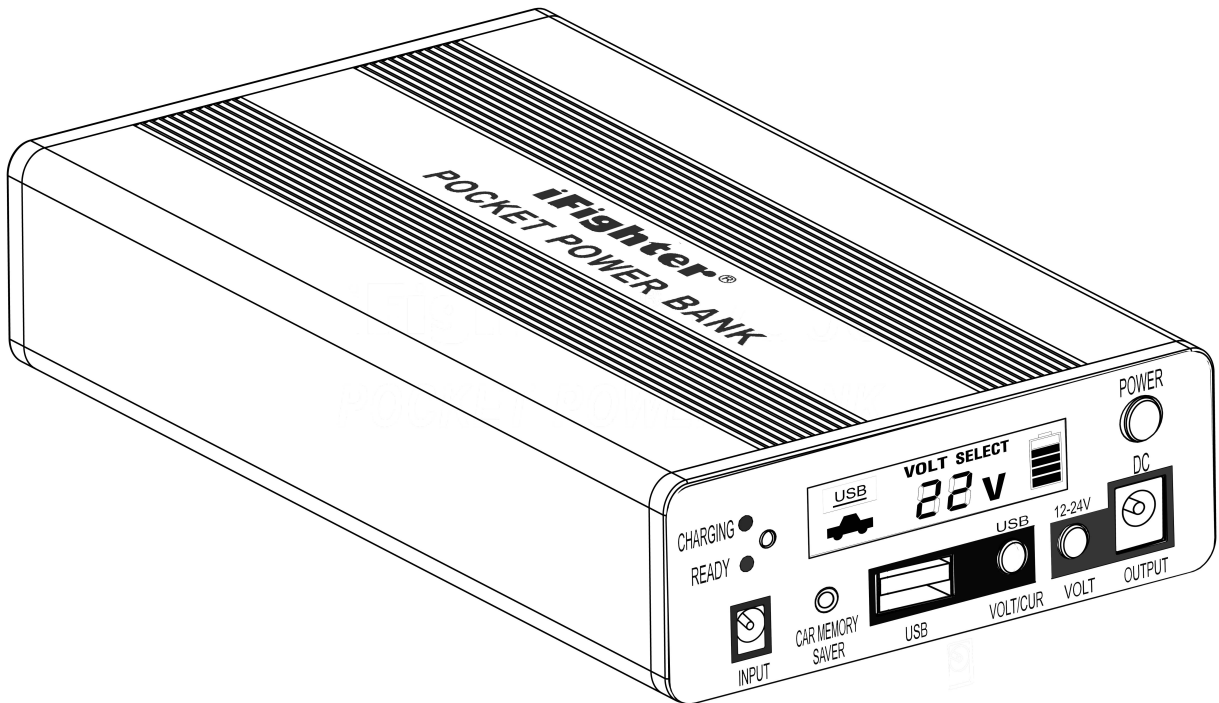

READ THESE INSTRUCTIONS CAREFULLY AND COMPLETELY BEFORE OPERATION

THIS MANUAL CONTAINS IMPORTANT SAFETY AND OPERATING INSTRUCTIONS.

RETAIN YOUR RECEIPT AS "PROOF OF PURCHASE"

KEEP IN A SAFE PLACE FOR FUTURE
REFERENCE

ATTENTION!

Failure to follow these instructions and safety clauses may lead to personal injury and/or damage to the iFighter-5000/7500 and/or any device attached to the iFighter-5000/7500.

CAUTION:

- Use this device exclusively for the purpose for which it has been developed.
- Do not use this device in rain, extremely wet, humid or similarly high moisture content conditions.
- Keep this device away from all flammable material.
- Always ensure this device is in a safe, complete and undamaged condition prior to use.
- This device should be used and kept on a flat, secure surface where any chance of falling or impact is minimized.
- Do not expose this device to constant direct sunlight and / or other source of heat.
- Throwing, dropping or causing heavy impact with this product may cause it to malfunction and will void warranty..
- Keep this device away from young children. Use under adult supervision at all times.
- Competent supervision and instruction should be given to all persons operating this device that may not be able to read these instructions, fully understand them or whom may have physical difficulties in performing the tasks outlined herewith.
- Never attempt to alter or disassemble this product. Doing so will void the warranty.
- Repairs and maintenance must only be performed by authorized specialists. In the unlikely event of a problem with this device please contact the place of purchase for further instructions and assistance.

1. Product Control Panel and indicators:

- 1.1. Power On/Off switch
- 1.2. DC Power output jack to 24Vdc.
- 1.3. Voltage selector – 12V, 15V, 16V, 19V, 20V, 22V and 24V selectable
- 1.4. LCD monitor for showing the status of the iFighter battery, selected voltage, current, and operational status.
- 1.5. USB output current selector, 0.3A and 2.0A selectable
- 1.6. USB ver. 3.0 dc power outlet, 4.2V/ 5.0V selectable
- 1.7. Power back-up for 12V & 24Vdc - car memory saver.
- 1.8. LED indicator for charge process.
- 1.9. Power input jack for recharging the iFighter battery
- 1.10. Light weight and rigid aluminum casing.

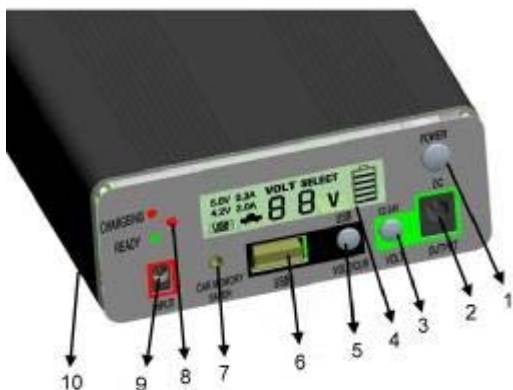

2. Operating Instruction:

2.1 Turning On the iFighter-5000 / 7500

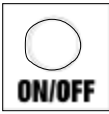
	<p>Press the On/Off button once to turn on the unit.</p>
---	--

2.2 Check the battery capacity indicator to establish the iFighter's state of charge.

	<p>Battery Indicator</p>	<p>Battery Power Left</p>
	<p>Fifth Bar Forth Bar Third Bar Second Bar First Bar</p>	<p>100% 80% 60% 40% 20%</p>

Note: When the battery capacity is low the backlight of the LCD will flash when the unit is On.

2.3 Recharging the iFighter-5000 / 7500:

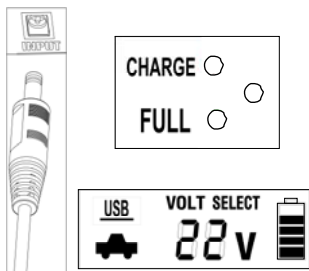
	<p>Connect iFighter-5000 / 7500 to the supplied battery charger or car lighter socket to initiate charging. When the iFighter is charging a red light will flash. Once the iFighter battery is full the green light will illuminate.</p> <p>The LCD will show the status of battery via 5 percentage bars</p>
--	---

2.4 Charging a Notebook computer via iFighter-5000 / 7500

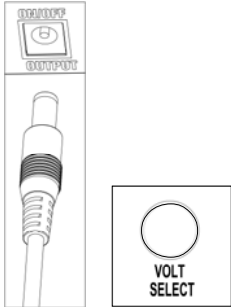
	<ul style="list-style-type: none"> - Choose the correct interchangeable plug for the Notebook . - Connect the chosen plug to the 800mm cable provided and then into the notebook. - Select the voltage required by the notebook, ie, 12V, 15V, 16V,19V, 20V, 22V or 24V. By pressing the “Volt Select” button until the correct voltage is shown in the LCD screen. -Connect the cable into the output jack of the iFighter.
---	--

2.5 Charging an electric device or digital camera via iFighter-5000 / 7500

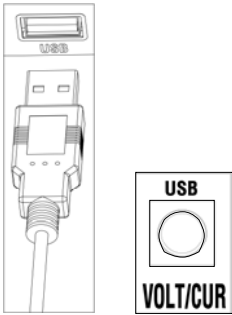
	<ul style="list-style-type: none"> - Connect the electronic device to the ‘USB outlet’ via a USB cable. iFighter-5000 / 7500 is compatible with many mobile phones, MP4, MP3’s, digital cameras and similar devices. - Press “USB Volt/Cur” button to select the desired current output (0.3A or 2.0A). The selected current will be shown on the LCD. - Hold the “USB Volt/Current” button for 5 sec for 4.2VDC USB voltage output.
---	---

2.6 Car memory saver

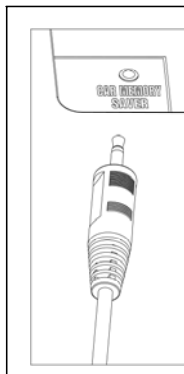

- Connect the Car cable into the “Car Memory Saver” port.
- Connect the other end of the cable into the car lighter/auxiliary socket. This will maintain the memory of vehicle’s electronics system while the vehicle’s battery is disconnected for replacement or during maintenance.
- The car icon will illuminate when in car memory mode.
- Note: The iFighter must be in a charged state to act as a memory saver.

3. Features:

- 3.1. 100% recharge possible via 12Vdc Car lighter/auxiliary outlet.
- 3.2. Extra Power source/runtime for Notebook computers
- 3.3. Wide range of selectable voltages for powering various kinds of electronic devices.
- 3.4. 17 interchangeable DC jacks to suit numerous DC devices and laptops/notebooks
- 3.5. USB ver.3.0 power outlet with selectable current and voltage.

Ideal for charging:

MP3 / MP4, cell phone, digital cameras, tablets, notebooks and many more devices

- 3.6. One Year Warranty.

4. Accessories included:

- 4.1. AC switching mode battery charger
- 4.2. 12V DC to DC charge cable
- 4.3. 12Vdc output cable with DC jack adaptor
- 4.4. 12Vdc output cable for car memory saver
- 4.5. USB output cable
- 4.6. One set of 8 interchangeable DC jacks.
- 4.7. Notebook connecting cable with 9 interchangeable jacks.

5. Specification:

Charging source; External AC switching mode power supply

- 5.1. Input : 110V – 240Vac 50/60Hz

Output: 12Vdc 1.0A

- 5.2. DC Input: Recharges from 12Vdc power source (via car lighter/auxiliary plug) .

- 5.3. Output Ranges : 12V, 15V, 16V, 19V, 20V, 22V and 24V selectable, 4.0A Max.

- 5.4. USB output : 4.2Vdc/ 5Vdc 0.3A / 2.0A max. both selectable.

- 5.5. Battery Cell Type: Lithium Polymer

- 5.6. Capacity: 5000mAh 11.1V (**iFighter 5000**) or 7500mAh 11.1V (**iFighter 7500**)

- 5.7. Battery Cycle life: Approx 500 Cycles to 70% of original capacity.

- 5.8. Dimensions: **iFighter 5000**

(L) 178mm x (W) 100mm x (H) 38mm

- iFighter 7500**

(L) 210mm x (W) 120mm x (H) 38mm

- 5.9. Net Weight: 1.2kgs

1.5kgs

Gross weight: 1.5kgs

1.8kgs

6. TROUBLE SHOOTING CHECK LIST

Symptoms	Solution
1. The iFighter will not power up	- iFighter battery may be exhausted. Recharge the battery.
2. No indicators on LCD	- Check the power switch is “ON” and the battery has enough capacity to power the unit. Recharge the battery to be sure.
3. No output power occurs when Car Memory Saver is connected	- Be sure to check the DC output is compatible with the Car Memory Saver Auxiliary Socket. - In case of no output to DC plug, remove plug from Car Memory Saver and check fuse and/or try an alternative socket.
4. The battery does not charge	- Make sure the charger is properly connected to the mains socket. - Ensure the charger jack is firmly inserted in the input jack. - Ensure the mains socket is working by testing with a lamp, hair dryer etc

Limited Warranty

7.1. The manufacturer warrants this device against all defective parts or faulty workmanship for a period of (12 months) from date of purchase.

7.2. This warranty excludes any damage caused by dropping or impact accidents of any kind, use outside those for which the device has been designed, improper connection, input power surges or voltage fluctuations. Any other performance claims and statements made by the distributor/retailer shall be the exclusive liability of that party. Furthermore, this warranty does not cover wear or damage caused to other goods or assets as a result of a fault in the device under warranty.

7.3. This warranty is only valid when accompanied by the original invoice or Sales receipt.

7.4. This warranty will become null and void if the device is opened or worked upon by personnel other than those duly authorized to do so in writing by the manufacturer.

7.5. If this product is in any way defective (other than resulting from abnormal use) within the stated period, you can, at your cost, return it (with it's original packaging if possible) with purchase receipt to the place of consumer purchase or call: (02) 9519-1200 or email: returns@master-instruments.com.au for an issuance of a Return Goods Authority Number. Our goods come with guarantees that cannot be excluded under the Australian Consumer Law. You are entitled to a replacement or refund for a major failure and for compensation for any other reasonably foreseeable loss or damage. You are also entitled to have the goods repaired or replaced if the goods fail to be of acceptable quality and the failure does not amount to a major failure. The benefits under this warranty are in addition to other rights you may have at law. This warranty against defects is provided by the import agent Master Instruments Pty Ltd 33-39 Sloane St Marrickville NSW 2204.